

Différentes sections de solides.

Doc. suivant

Doc. précédent

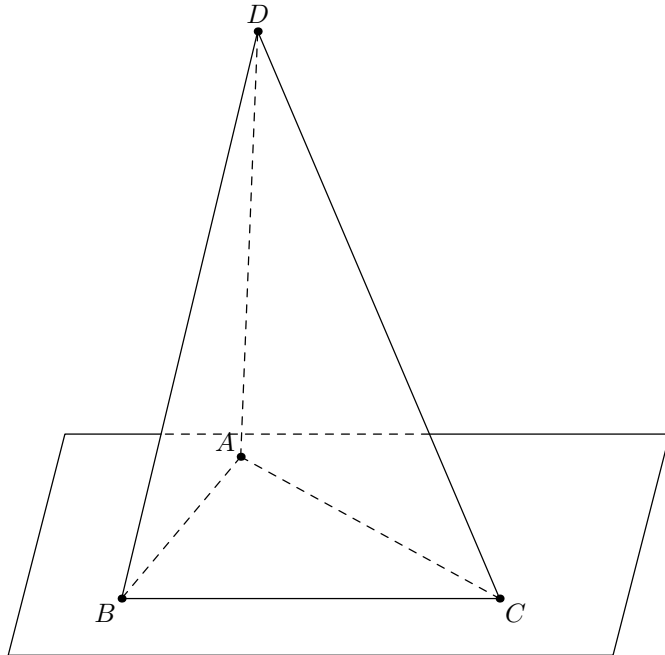



[Doc. suivant](#)

[Doc. précédent](#)



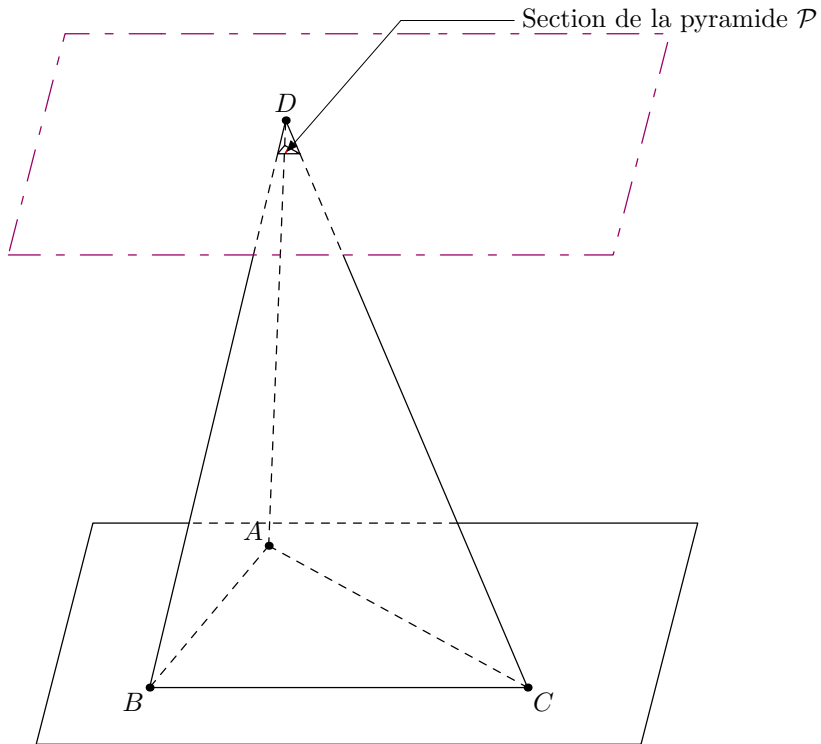

[Doc. suivant](#)

[Doc. précédent](#)



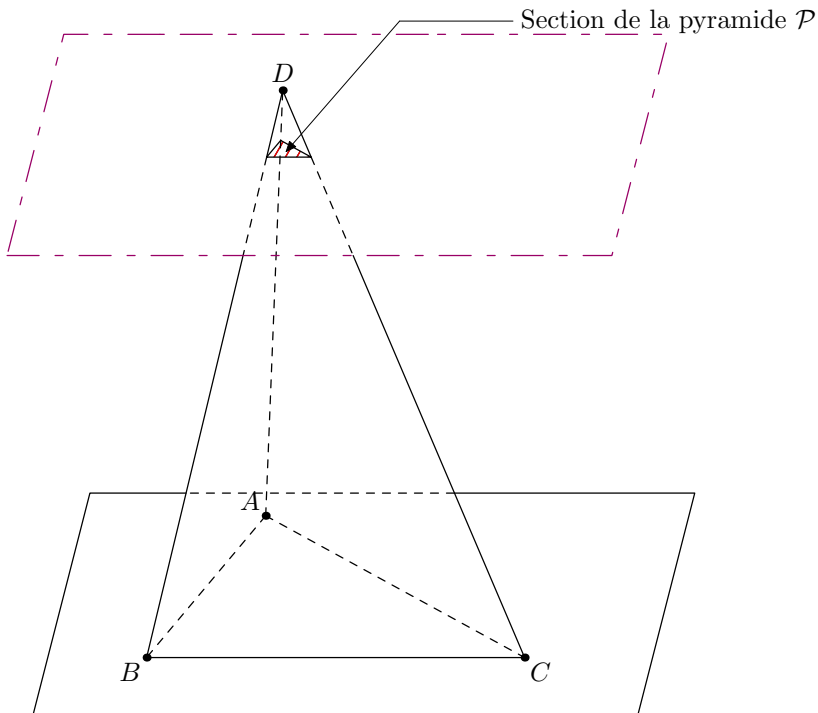

[Doc. suivant](#)

[Doc. précédent](#)



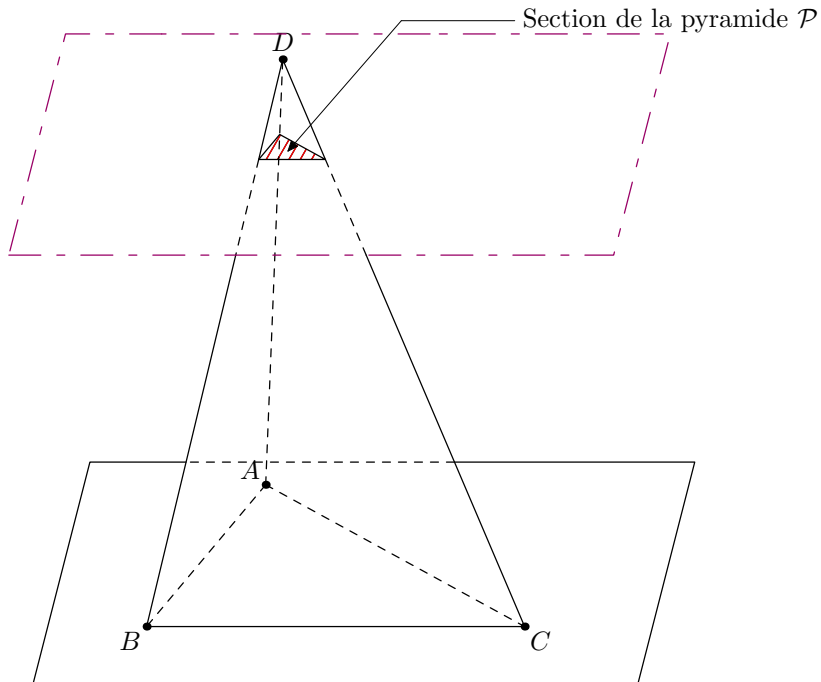

[Doc. suivant](#)

[Doc. précédent](#)



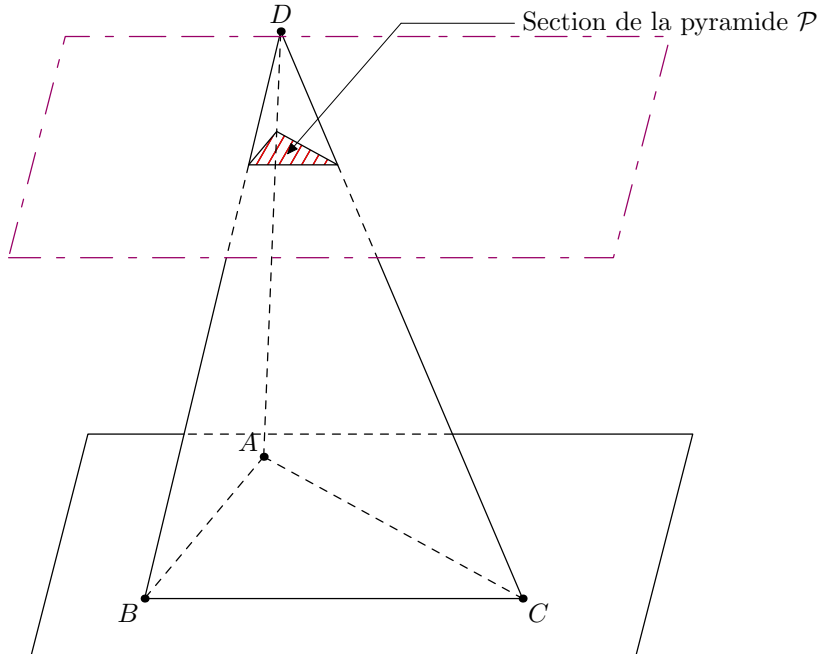

[Doc. suivant](#)

[Doc. précédent](#)



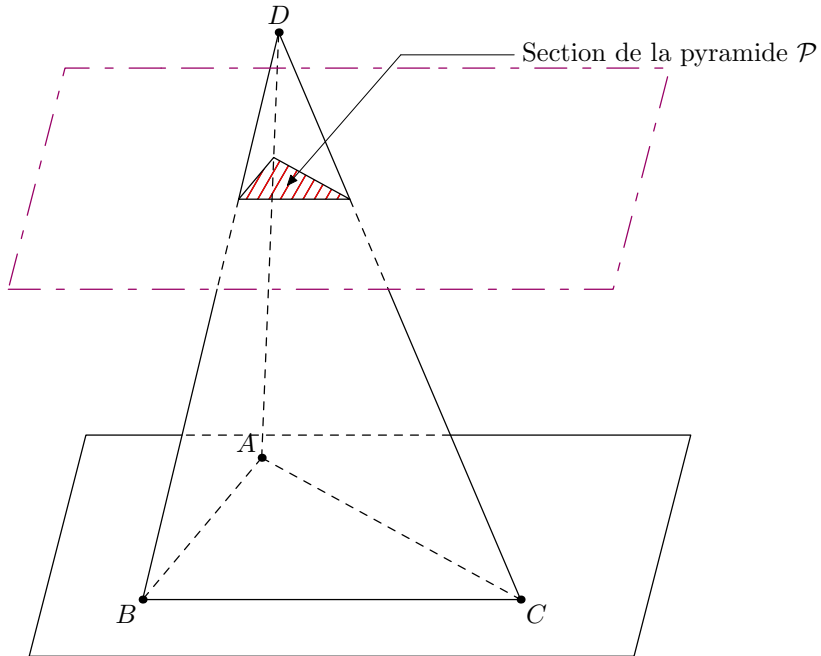

[Doc. suivant](#)

[Doc. précédent](#)



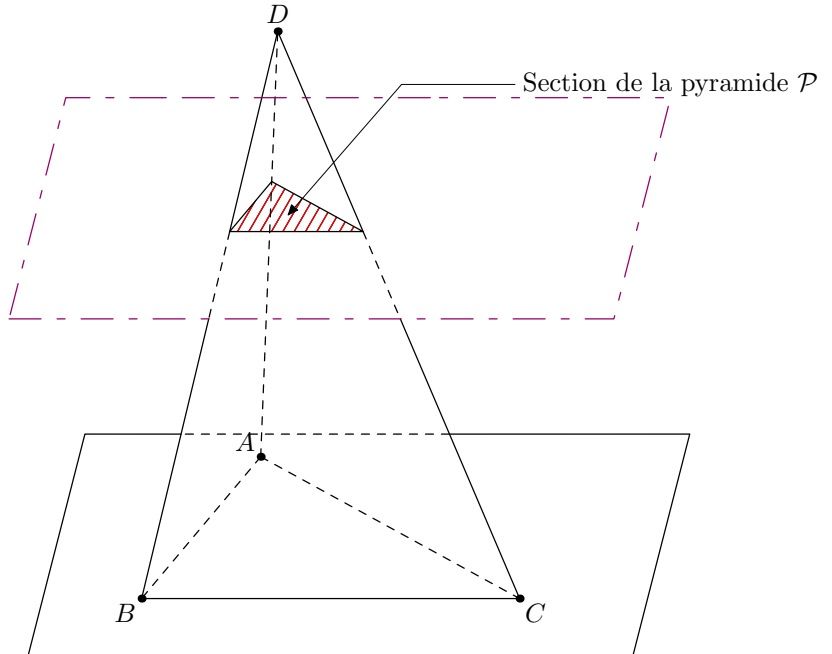

[Doc. suivant](#)

[Doc. précédent](#)



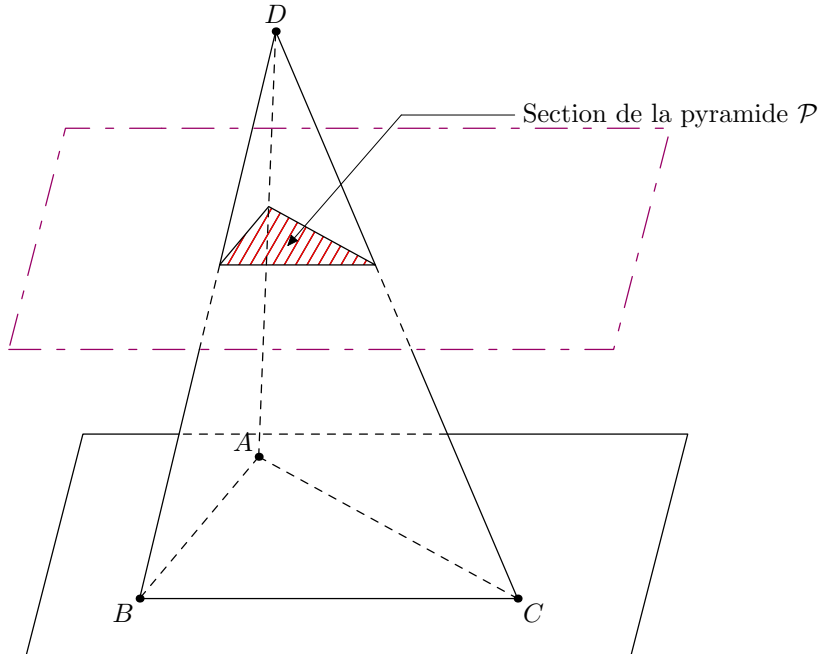

[Doc. suivant](#)

[Doc. précédent](#)



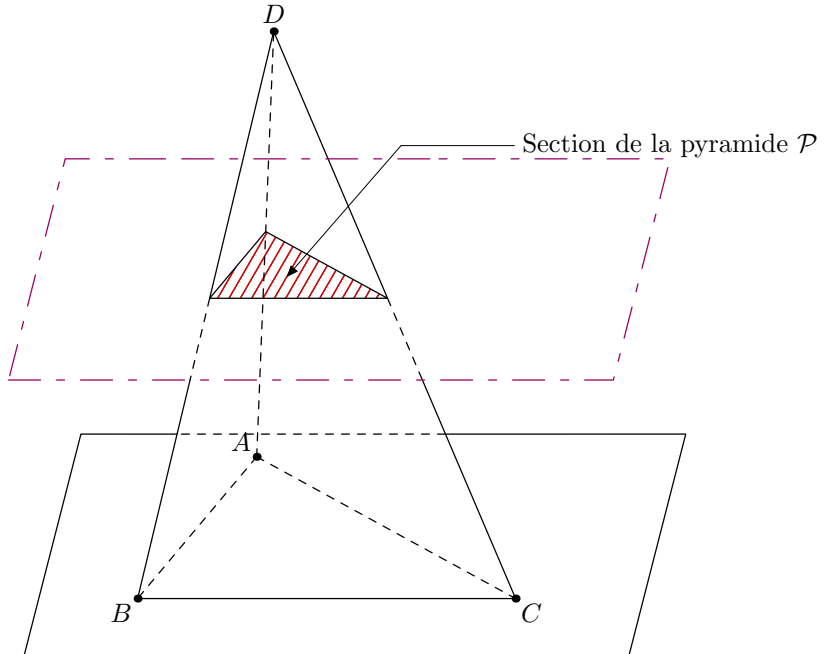

[Doc. suivant](#)

[Doc. précédent](#)



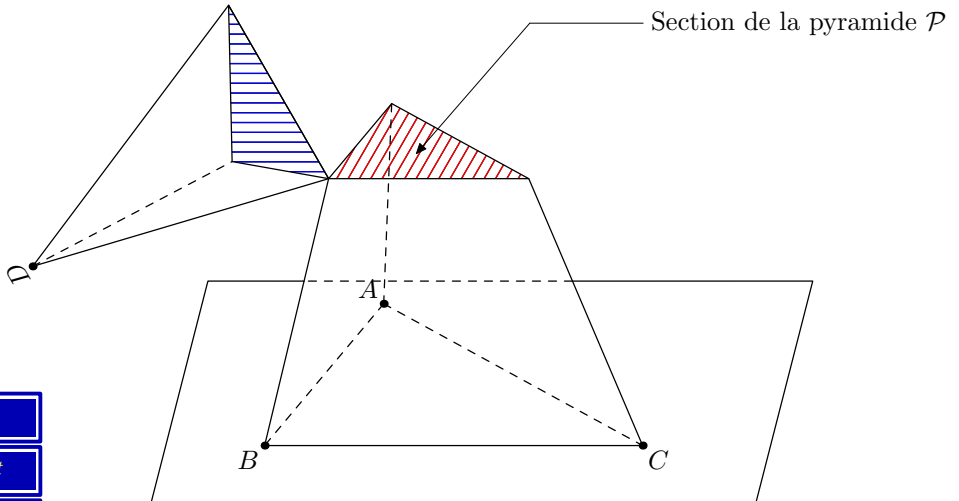

[Doc. suivant](#)

[Doc. précédent](#)



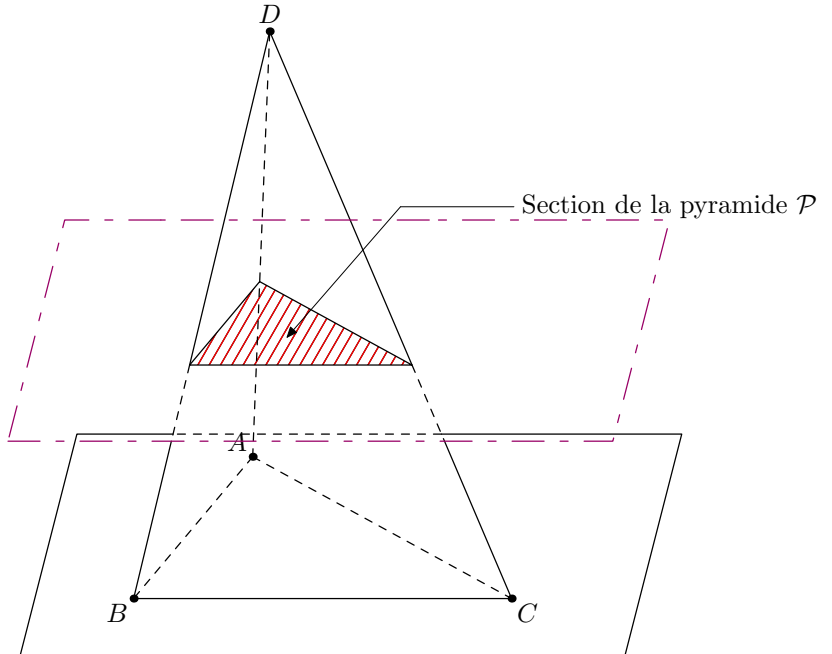

[Doc. suivant](#)

[Doc. précédent](#)



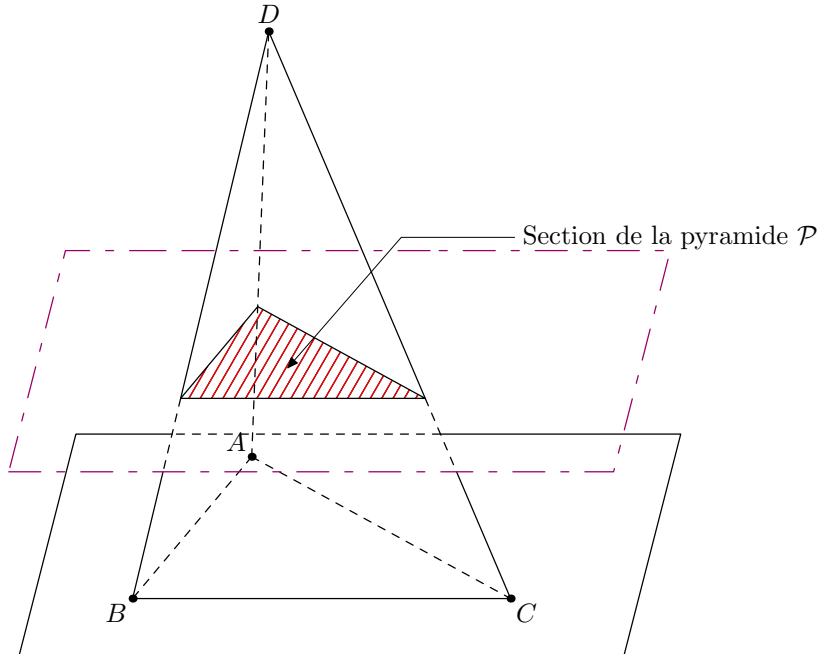

[Doc. suivant](#)

[Doc. précédent](#)



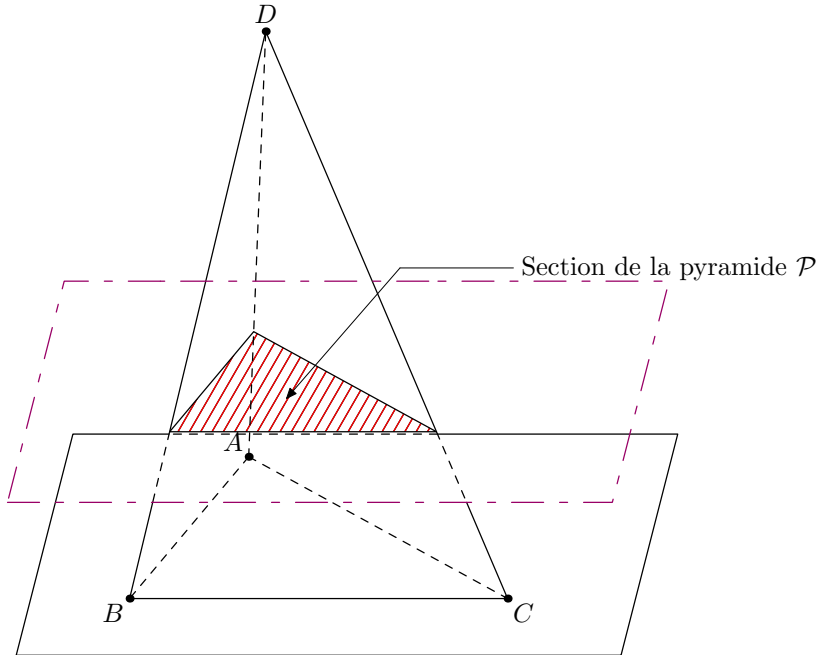

[Doc. suivant](#)

[Doc. précédent](#)

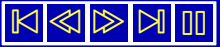

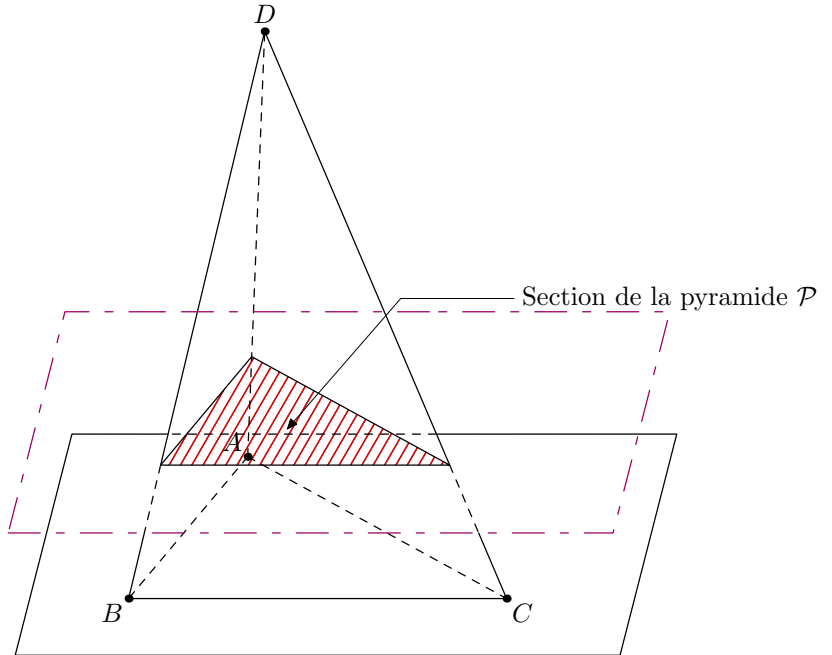

[Doc. suivant](#)

[Doc. précédent](#)



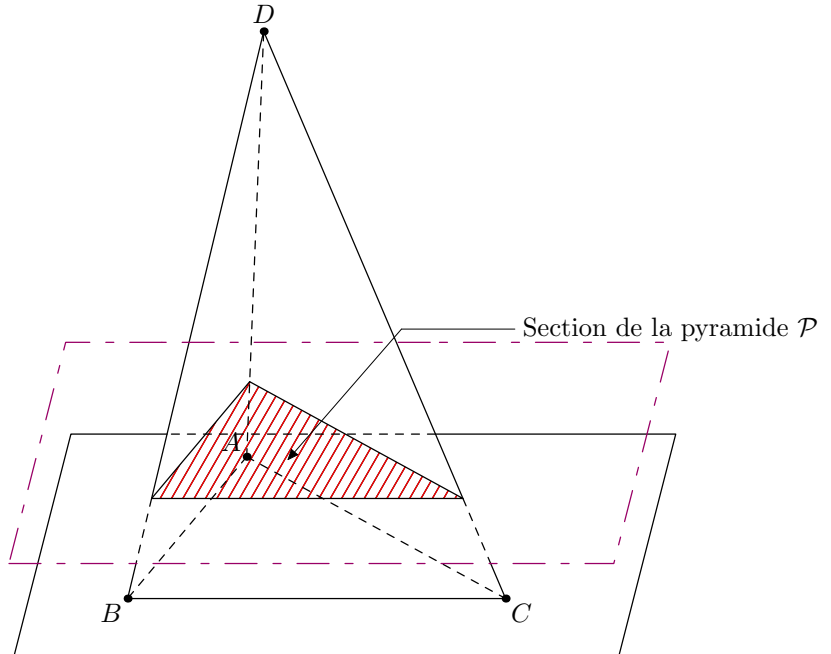

[Doc. suivant](#)

[Doc. précédent](#)



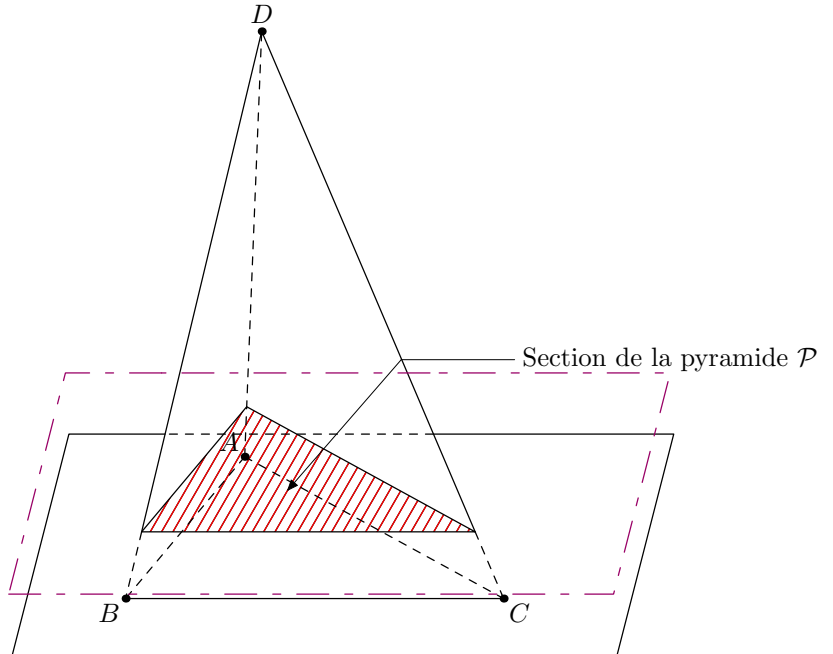

[Doc. suivant](#)

[Doc. précédent](#)

