

×
A

×
B

I●

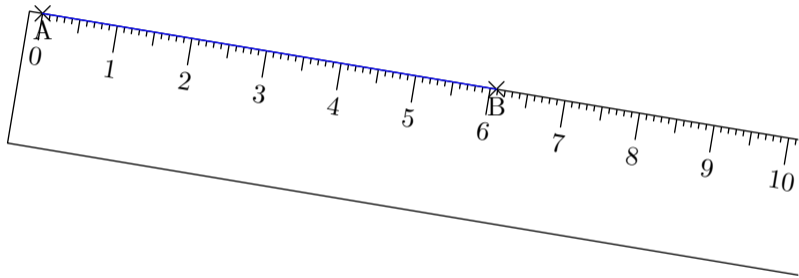

I•

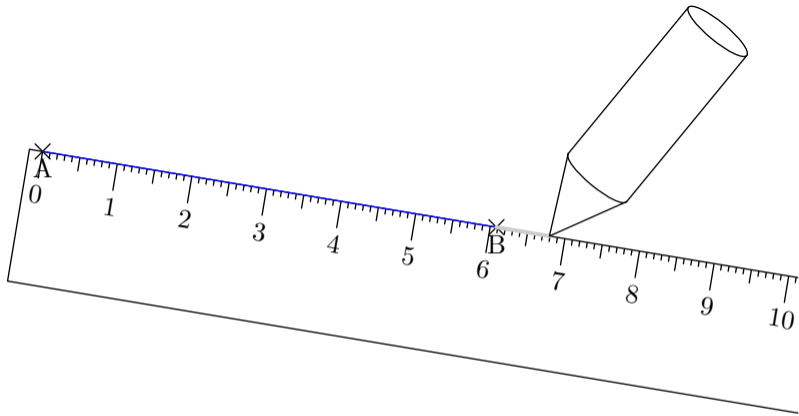

I •

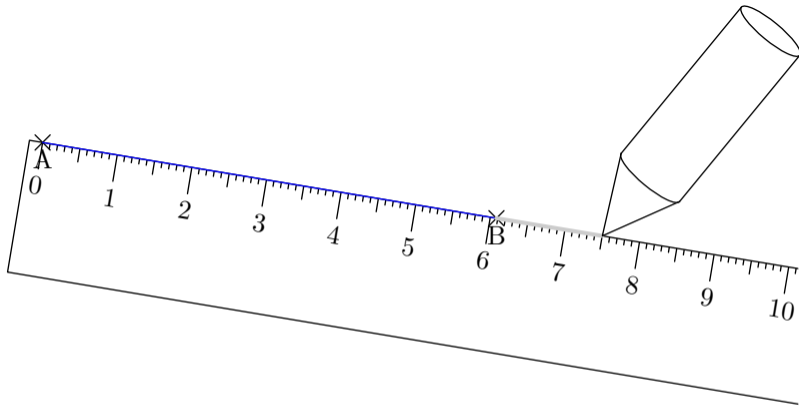

I●

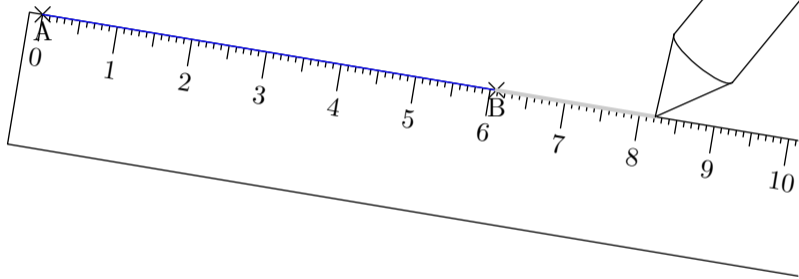

I●

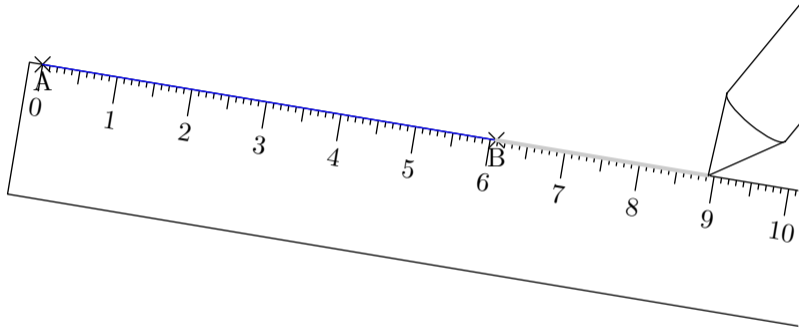

I •

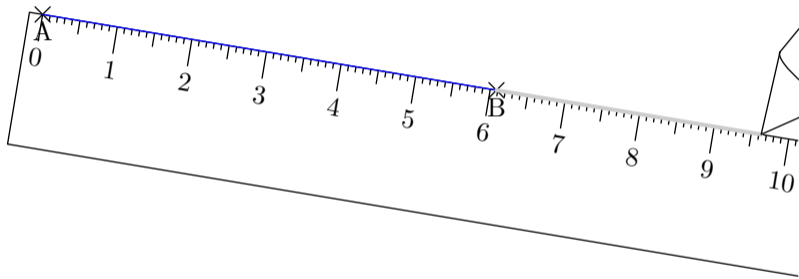

I •

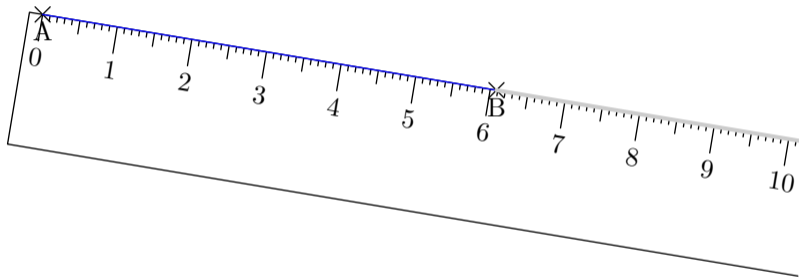

I •

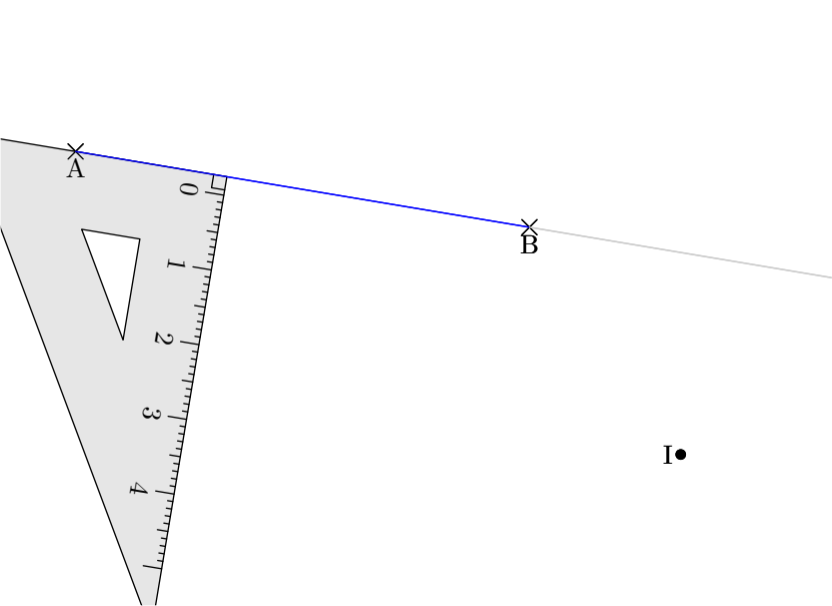

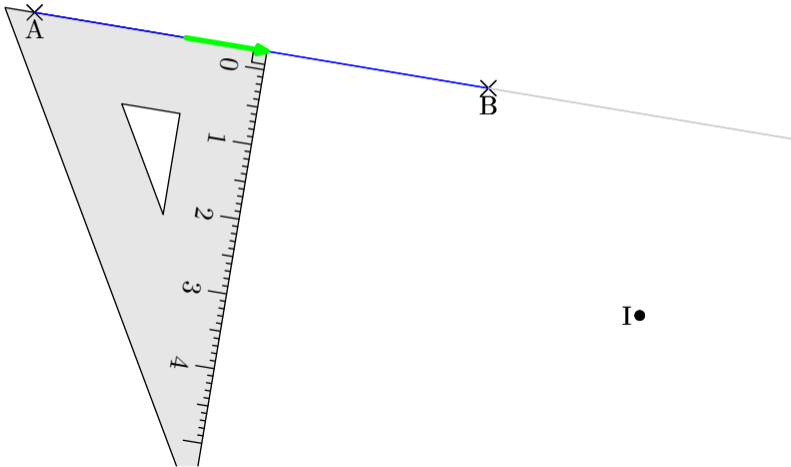

A

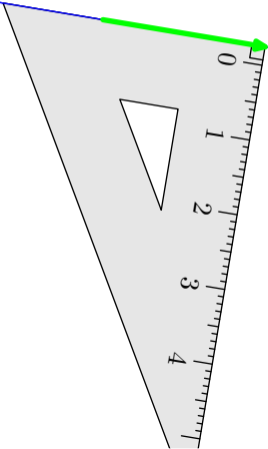

B



I •

A

B

I

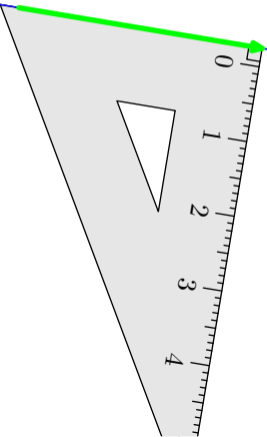

A

B

I

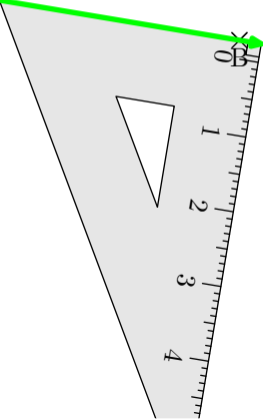
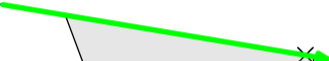

A

B

I

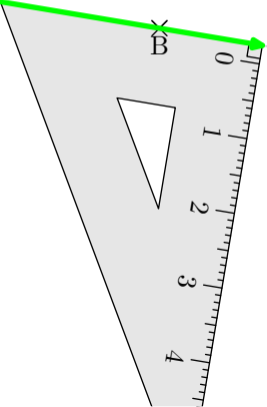
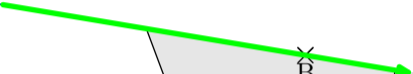

A

B



0

1

2

3

4



A

B

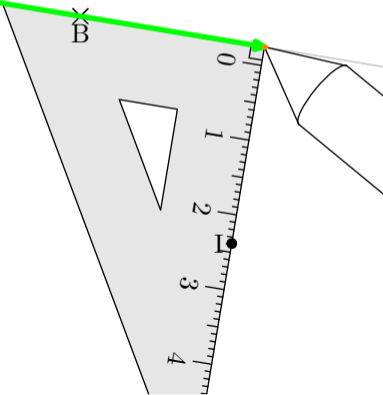
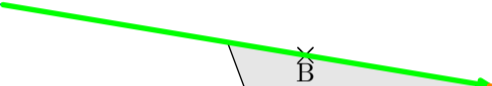

A

B



0

1

2

3

4



A

B

0
1
2
3
4

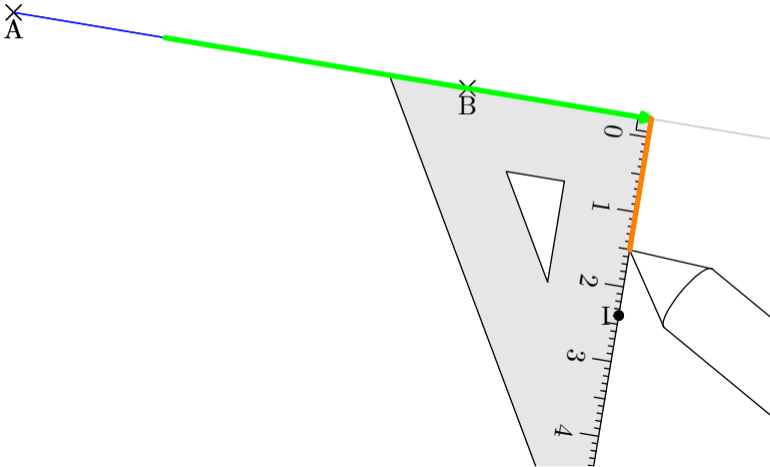

A

B

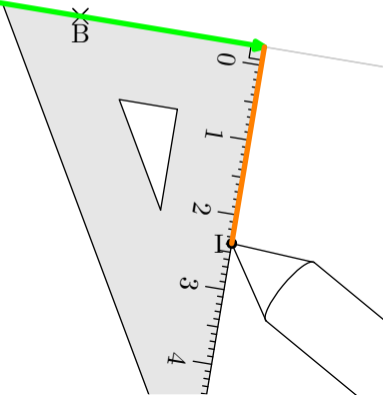

A

B

I

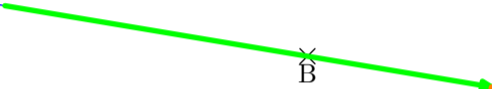

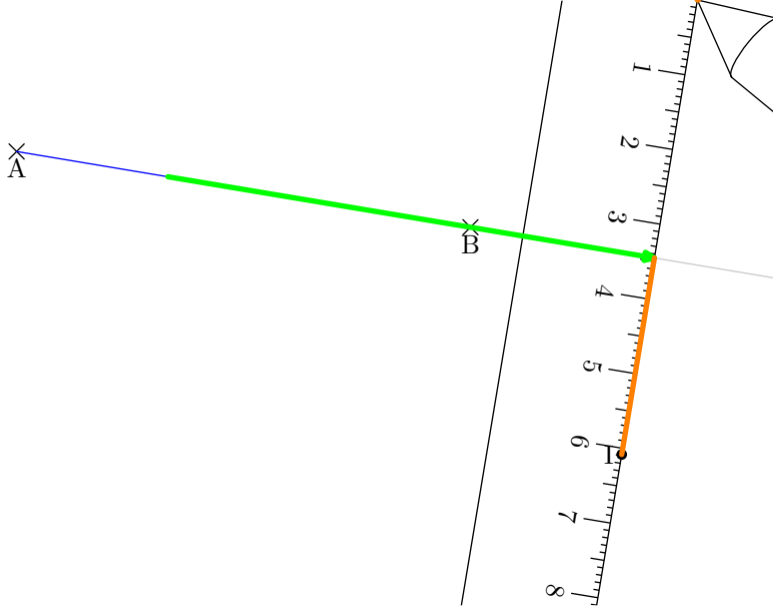

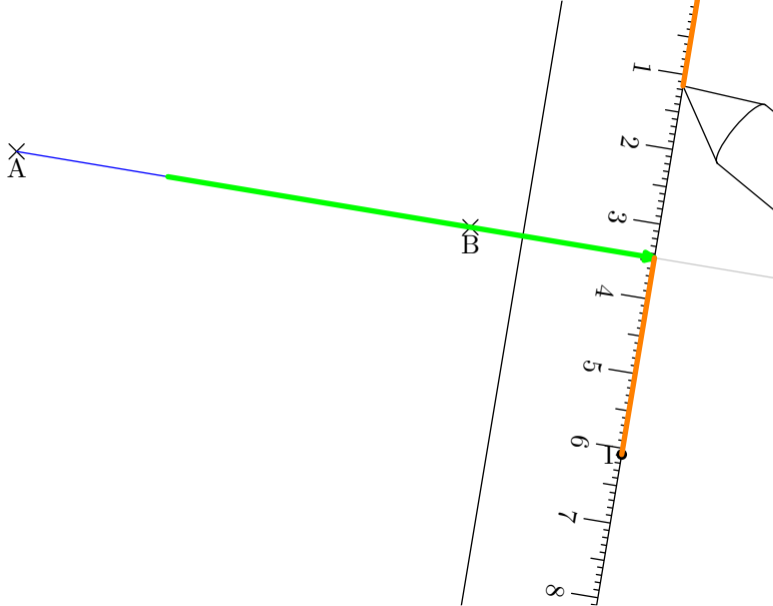

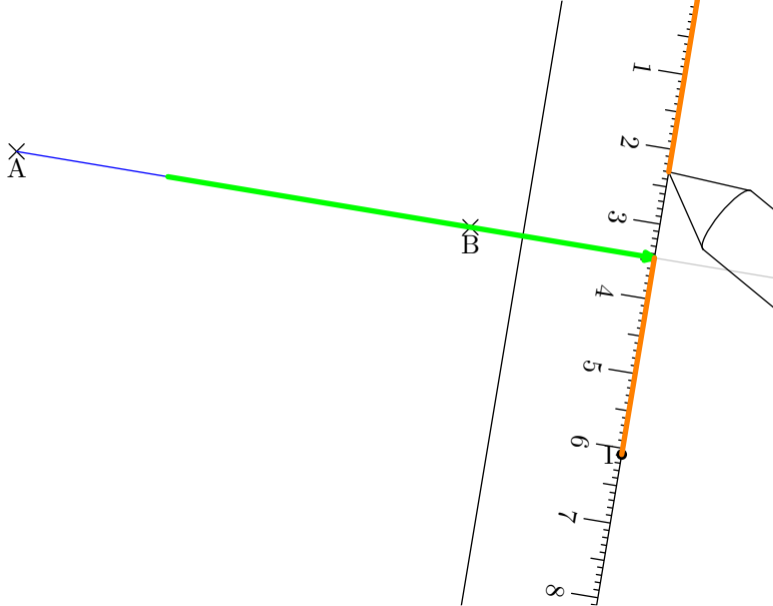

A

B

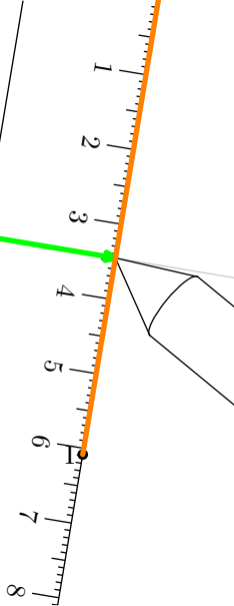

A

B

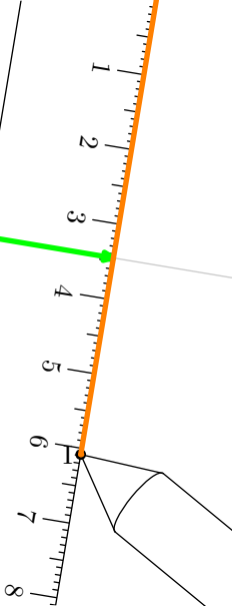

A

B

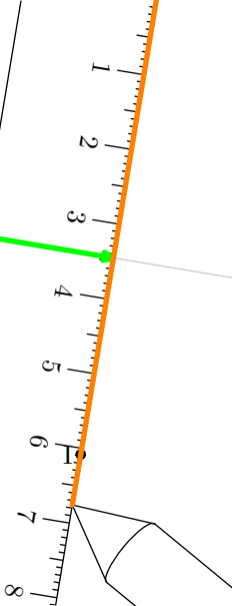

1

2

3

4

5

6

7

8

A

B

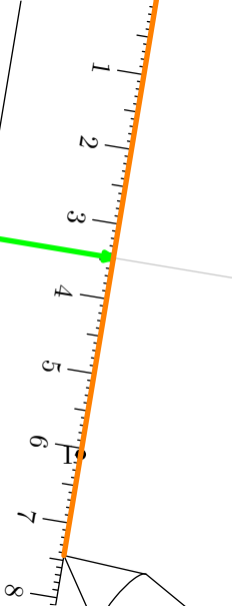

A

B

8

7

6

5

4

3

2

1

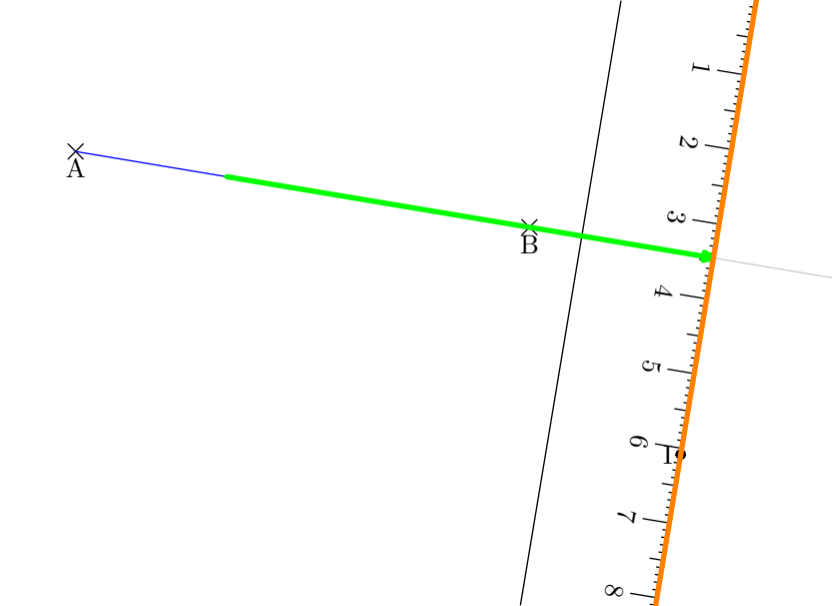

\times
A

\times
B

I

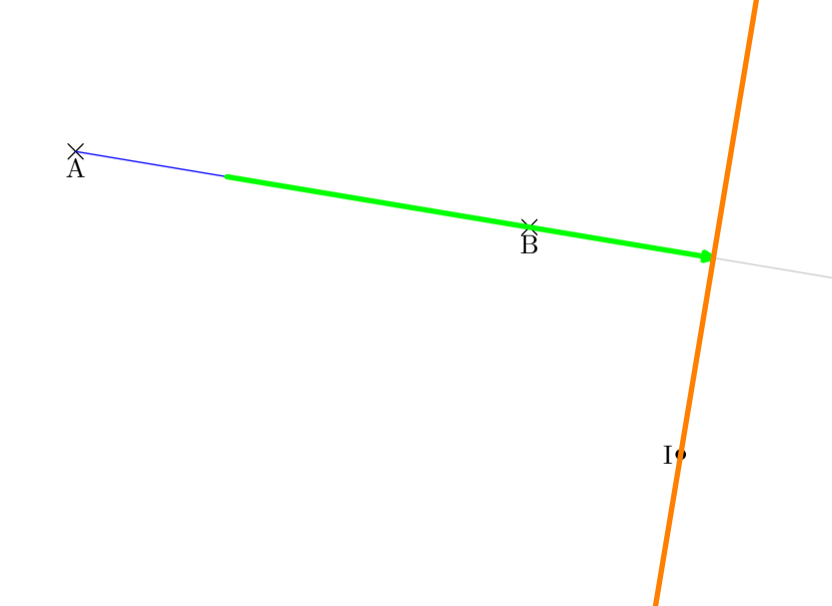

\times
A

\times
B

I



\times
A

\times
B

I

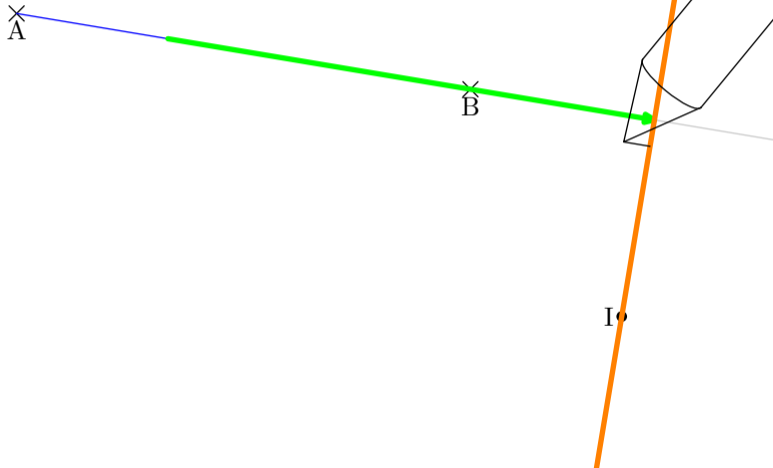

\times
A

\times
B

I

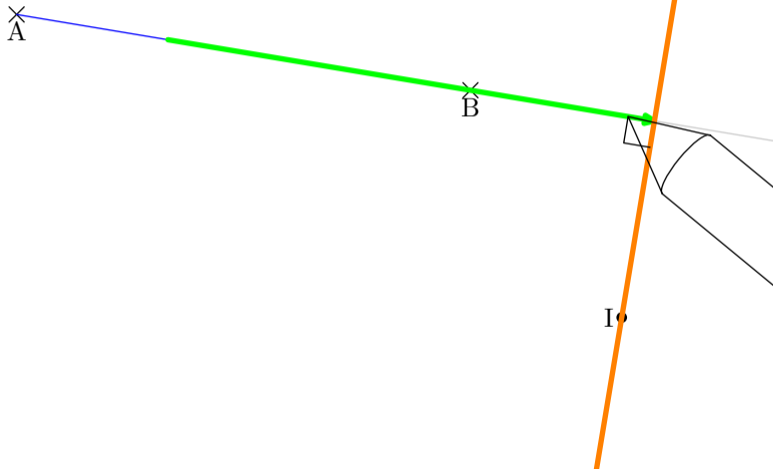

\times
A

\times
B

I

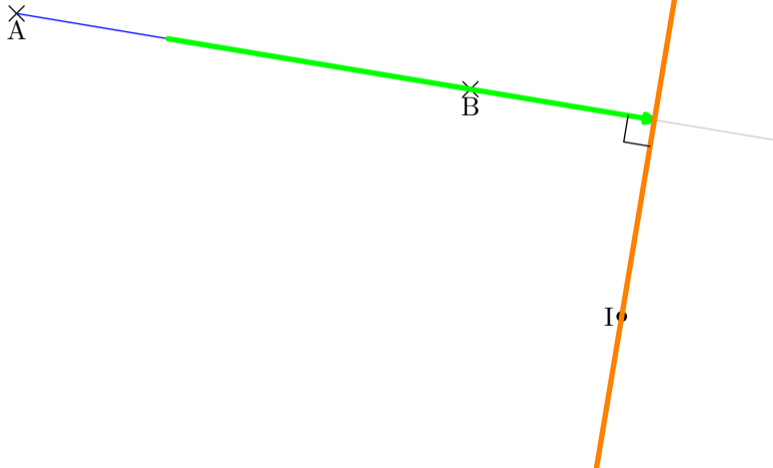

\times
A

\times
B

I

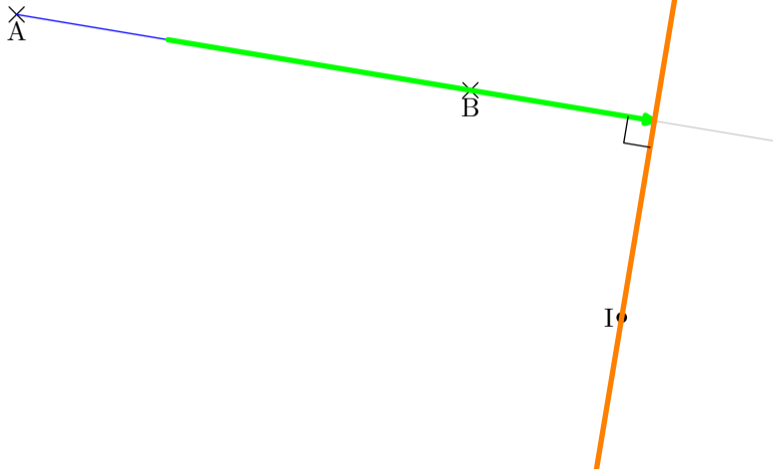

\times
A

\times
B

I

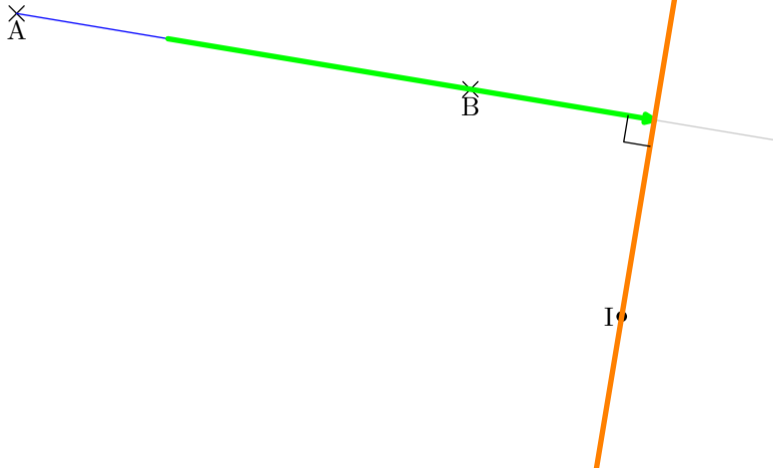

\times
A

\times
B

I

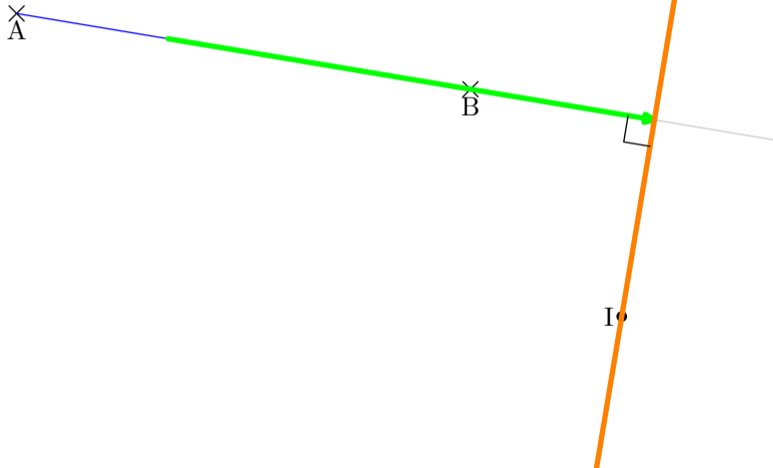

\times
A

\times
B

I

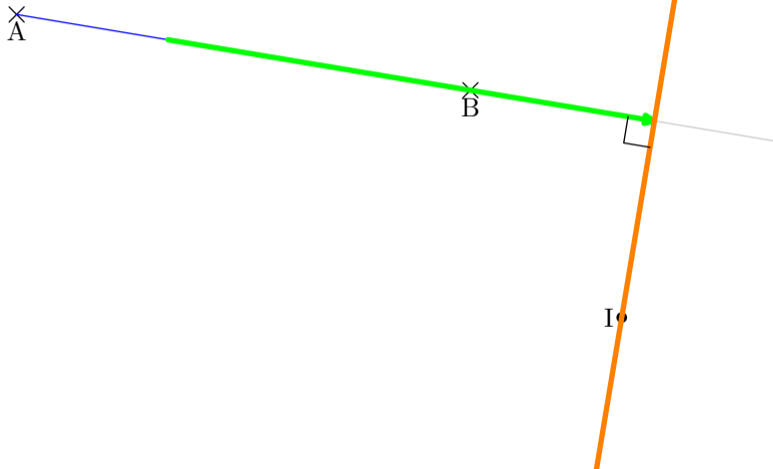

×
A

×
B

I

